



Technische
Universität
Braunschweig



A digital twin for evaluating evaporation pressure fluctuations in supermarket refrigeration systems

Andreas Schulte, TU Braunschweig

Agenda

1. Why did we want a digital twin for the evaporation pressure?
2. How did we go about building the digital twin?
3. What potential for automated model generation exist?
4. Where else can these methods be applied?

CO₂-Supermarket Refrigeration System

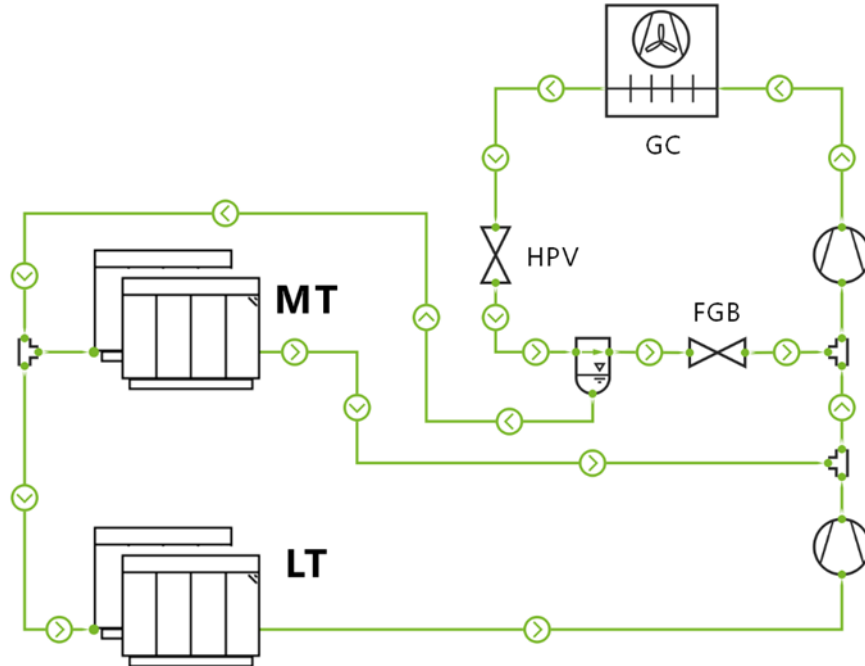

Typical evaporation pressure

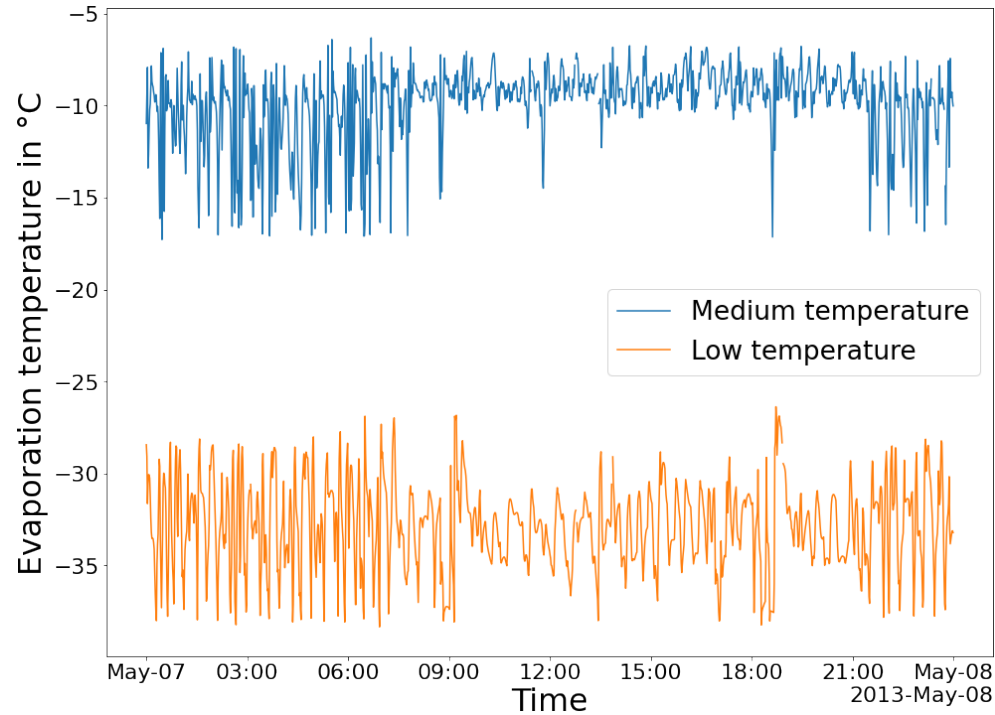

Motivation

- We assumed a more stable operation would lead to some energy benefits
- Different controller options influence the evaporation pressure dynamics
- The interactions within the system are very complex
- A digital twin is a good option to investigate this

Building a digital twin

- The digital twin will be build in Modelica (Refrigeration cycle) and Simulink (Controllers)
- The digital twin can be build by hand or automated
- We explored some ways of automated creation
- Ultimately we build the digital twin in a mix of automation and hand



Exploration of semi-automated model creation

Basic process for automatic model creation

1. Identify components
2. Determine system layout
3. Create Modelica code for the model:
 1. Build connections between components
 2. Add Parameter for the components

Determine system layout

- Finding all evaporators/ compressors that belong to a pressure level
- Correlation analysis and clustering
- Other clustering/ grouping algorithms may also work

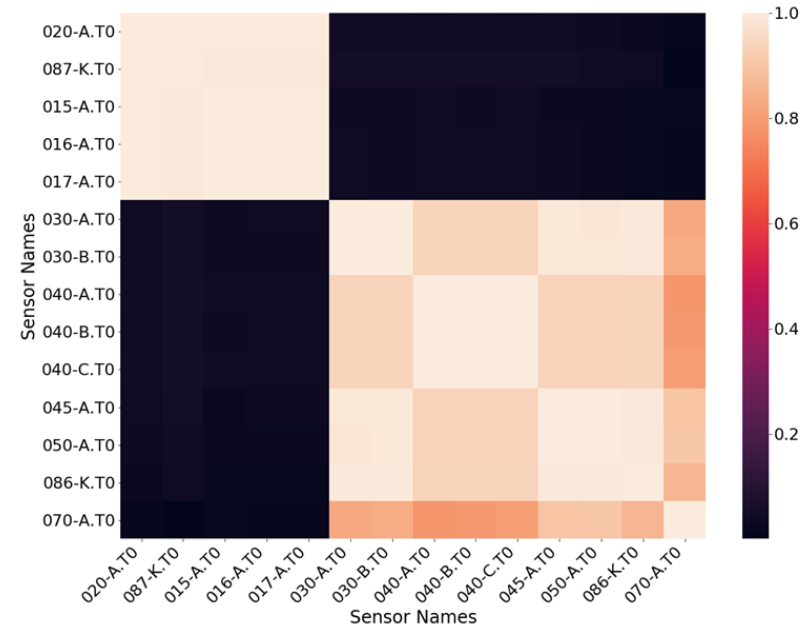

Schulte, A., Tegethoff, W., Köhler, J.: Correlation Analysis of evaporation pressure readings in CO₂ supermarket refrigeration systems. 15th IIR-Gustav Lorentzen Conference on Natural Refrigerants, Trondheim, 13.-15. Juni 2022.

Example

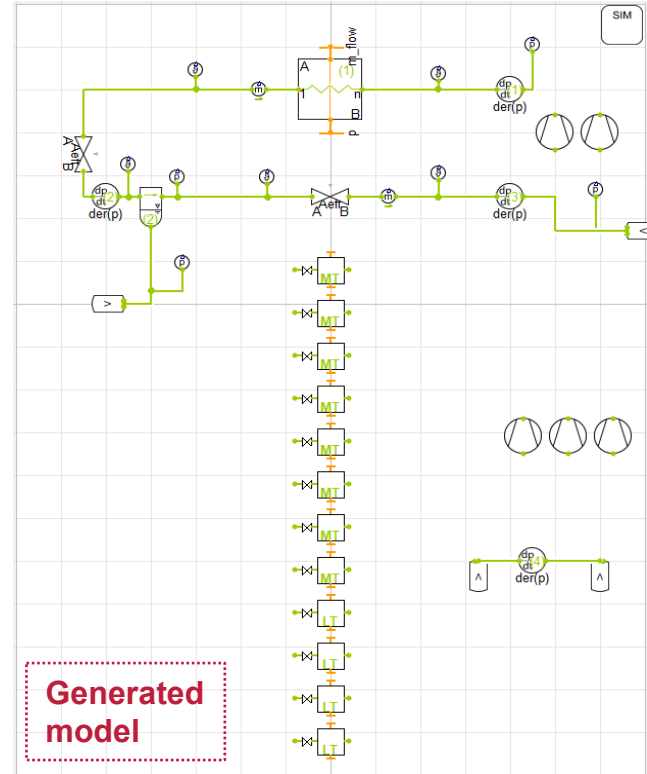
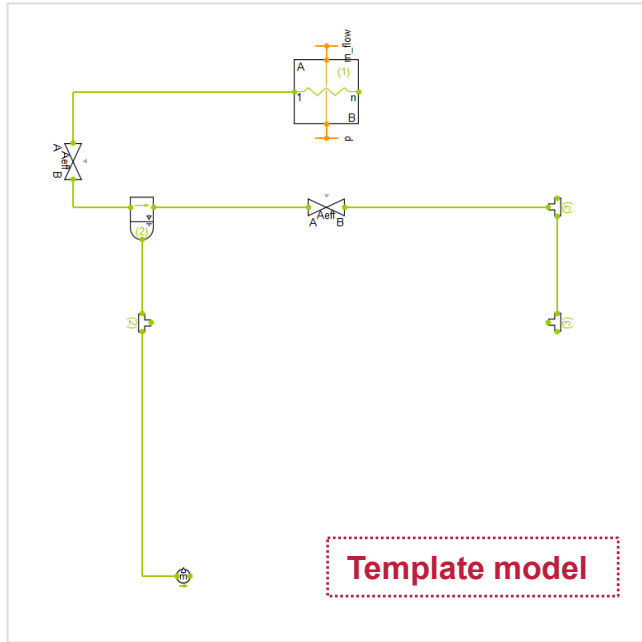

Example

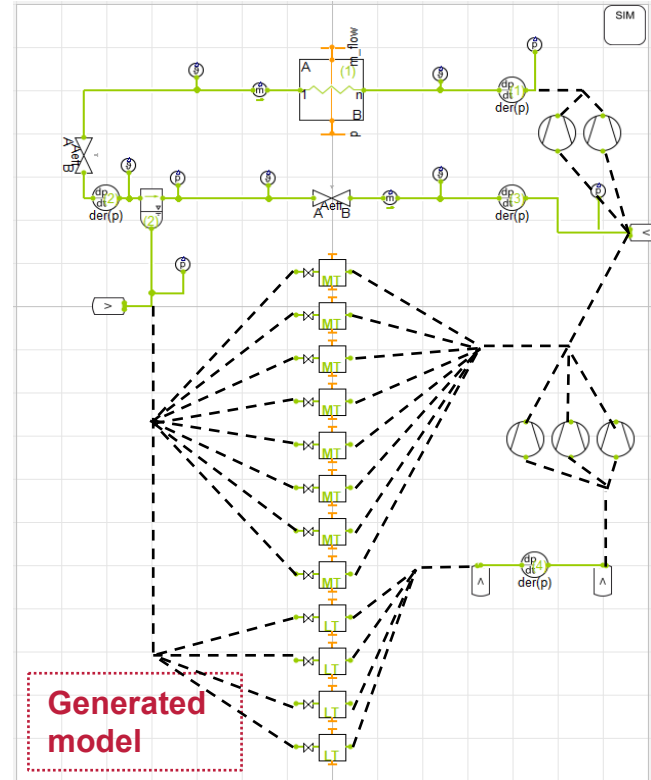
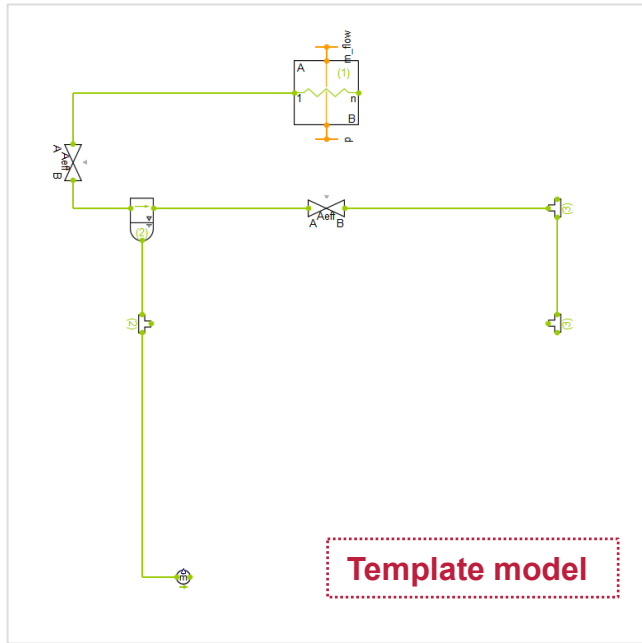

Identification of parameters

- 7 MT evaporators and 4 LT evaporators
- Dynamic cabinet models fitted to monitoring data
- Physics-based compressor models
- Semi-Automated process for the cabinets (Python-Script)

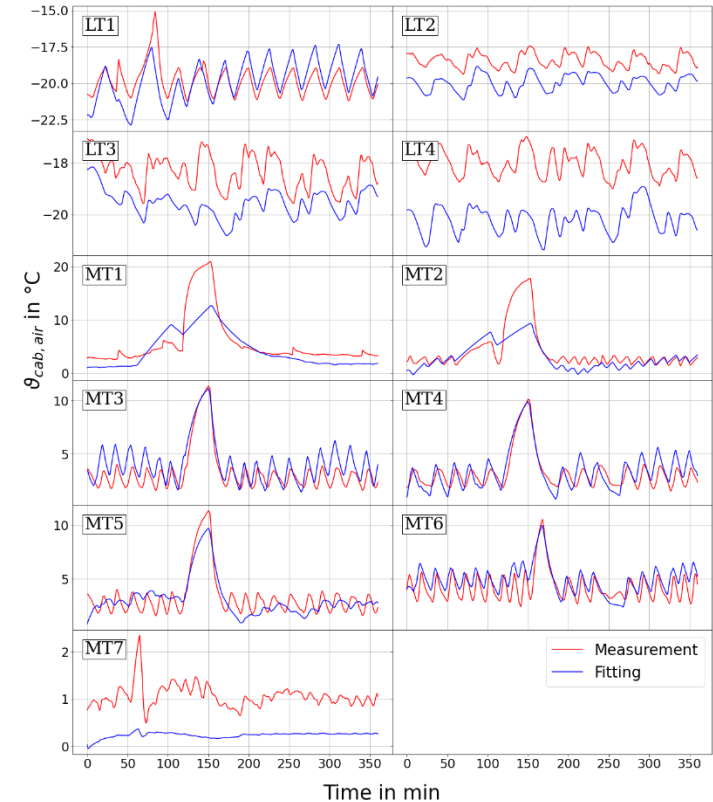

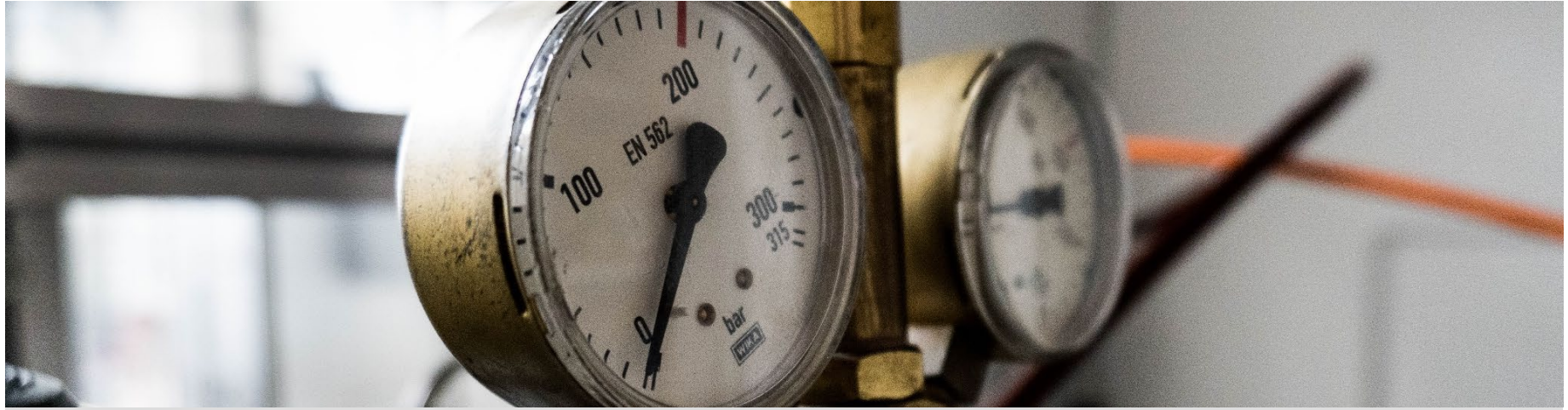

Results and Outlook

Daytime

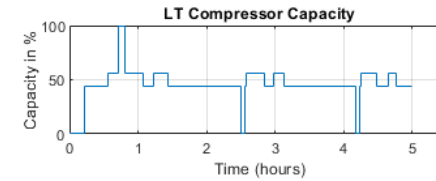
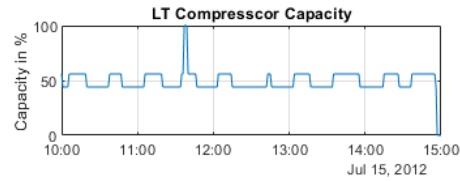
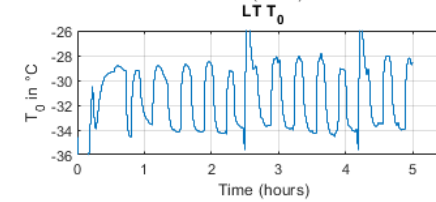
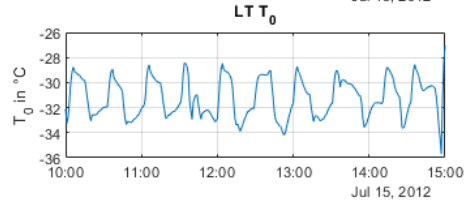
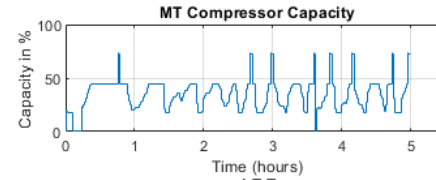
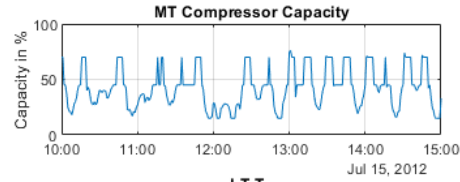
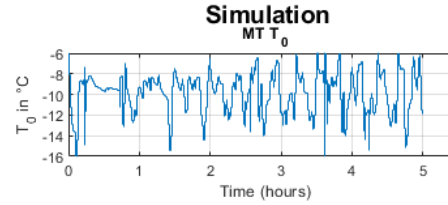
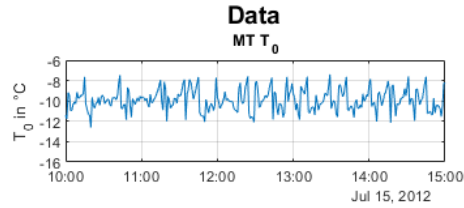

Results

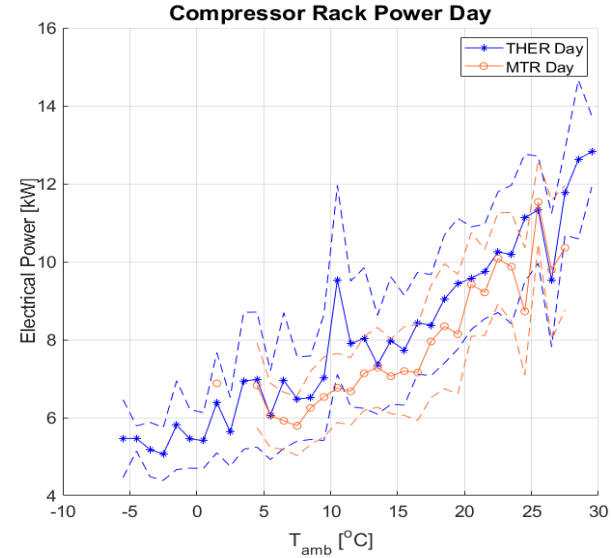
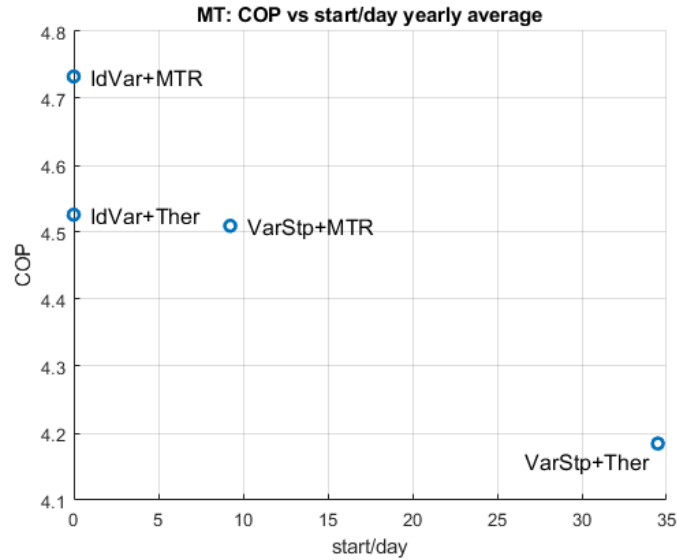

Schulte, A., Försterling, S., Larsen, L., Heerup, C., Bacher, P., Gøtsch, R., Tegethoff, W., Zühlsdorf, B., Koehler, J.: The influence of evaporation pressure dynamics on energy consumption. The 26th International Congress of Refrigeration, Paris, 21.-25. August 2023

Schulte, A.; Larsen, L.; Försterling, S.; Heerup, C.; Tegethoff, W.; Zühlsdorf, B.; Koehler, J.: Energy efficient control strategies in supermarket refrigeration systems. 8th International Conference on Sustainability and the Cold Chain, Tokyo, 10.-11. Juni 2024.

Summary

- We were able to build a digital twin of a supermarket refrigeration system that includes the controllers and interactions within the system
- The digital twin shows similar dynamics than the real system
- A more stable operation leads to energy benefits
- Fluctuations of the evaporation pressure are mainly driven by dynamic interactions within the refrigeration system

Outlook

- More automatic generation of simulation models for supermarkets seems possible
 - The usage of AI might improve automatic generation of digital twins
 - A wider adoption of simulation models will improve utilization of the results
 - Transfer of the knowledge to other system with multiple evaporators
- Initial work on a large air source heat pump has started as a master thesis

The End.

Farben der TU Braunschweig

R 190 G 30 B 60											R 8 G 8 B 8	R 95 G 95 B 95	R 150 G 150 B 150	R 192 G 192 B 192	R 221 G 221 B 221
R 255 G 205 B 0	R 255 G 220 B 77	R 255 G 230 B 127	R 255 G 240 B 178	R 255 G 245 B 204							R 198 G 238 B 0	R 215 G 243 B 77	R 226 G 246 B 127	R 238 G 250 B 178	R 244 G 252 B 204
R 250 G 110 B 0	R 252 G 154 B 77	R 252 G 182 B 127	R 253 G 211 B 178	R 254 G 226 B 204							R 137 G 164 B 0	R 173 G 191 B 77	R 196 G 209 B 127	R 219 G 228 B 178	R 231 G 237 B 204
R 176 G 0 B 70	R 192 G 51 B 107	R 215 G 127 B 162	R 235 G 191 B 209	R 243 G 217 B 227							R 0 G 113 B 86	R 77 G 156 B 137	R 140 G 191 B 179	R 191 G 219 B 213	R 218 G 234 B 231
R 124 G 205 B 230	R 164 G 220 B 238	R 189 G 230 B 242	R 215 G 240 B 247	R 229 G 245 B 250							R 204 G 0 B 153	R 222 G 89 B 189	R 235 G 153 B 214	R 245 G 204 B 235	R 250 G 229 B 245
R 0 G 128 B 180	R 77 G 166 B 203	R 140 G 198 B 221	R 191 G 223 B 236	R 217 G 236 B 244							R 118 G 118 B 118	R 152 G 64 B 152	R 186 G 127 B 186	R 214 G 178 B 214	R 235 G 217 B 235
R 0 G 83 B 116	R 64 G 126 B 151	R 140 G 177 B 192	R 191 G 212 B 220	R 217 G 229 B 234							R 118 G 0 B 84	R 156 G 77 B 136	R 193 G 140 B 178	R 221 G 191 B 212	R 235 G 217 B 230